

LINCOLN 5 - DIMENSIONS

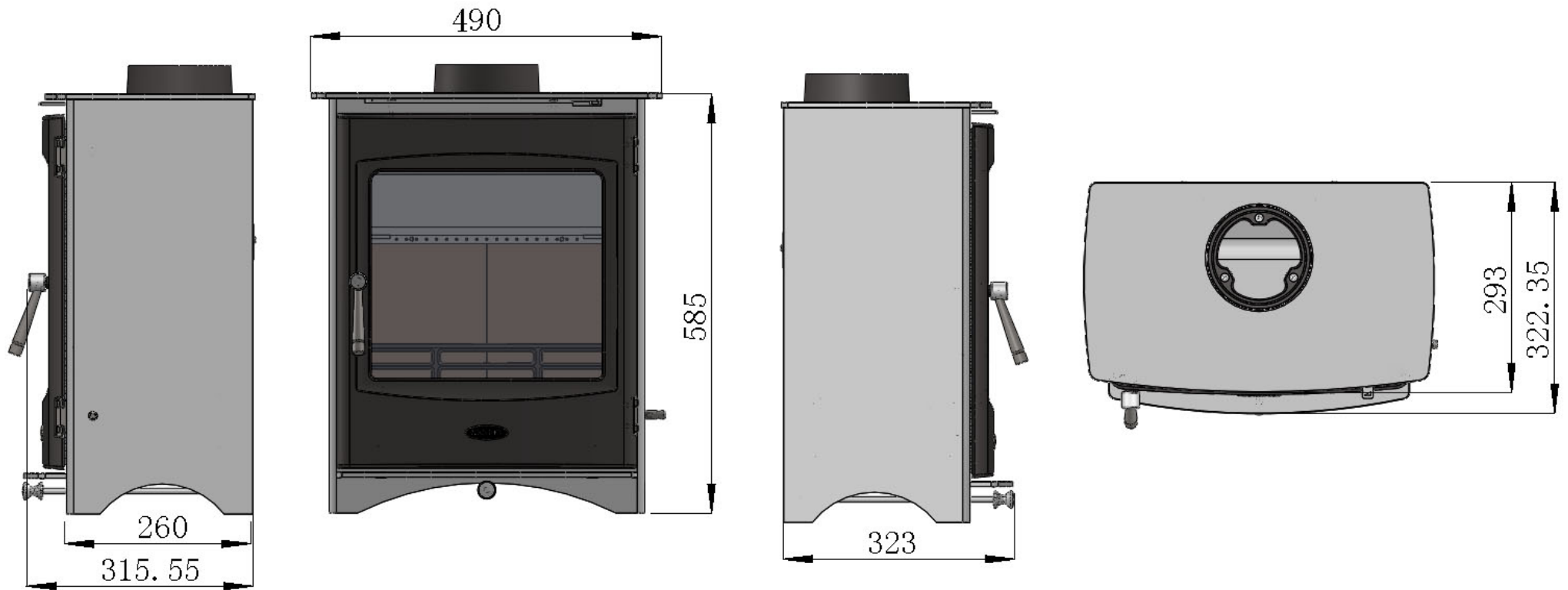

*All measurements in millimetres (MM)
All Dimensions are correct at time of publishing, but may be subject to slight change.
Please confirm exact dimensions before commencing installation works

HEIGHT: 585mm | WIDTH: 490mm | DEPTH: 323mm | FLUE SIZE: 125mm